

## Conveyor chain with special attachments (B series) Accesorios especiales para cadenas transportadoras (Serie B)

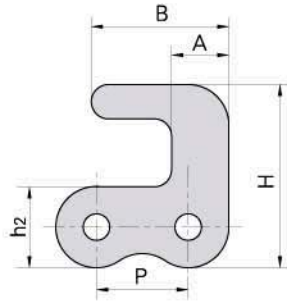

Donghua Chain No. Donghua Cadena No	P	h2	H	A	B
	mm	mm	mm	mm	mm
05BF1	8.0	7.1	16.0	5.0	12.0

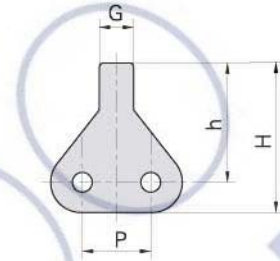

Donghua Chain No. Donghua Cadena No	P	H	h	G
	mm	mm	mm	mm
05BF3	8	17.55	14	4

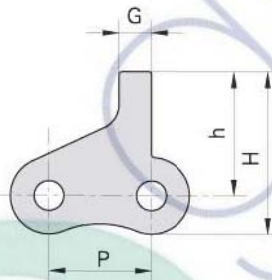

Donghua Chain No. Donghua Cadena No	P	H	h	G
	mm	mm	mm	mm
05BF4	8	12.7	9.7	2.5

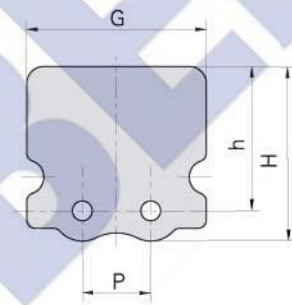

Donghua Chain No. Donghua Cadena No	P	H	h	G
	mm	mm	mm	mm
05BF6	8	17.55	16.95	21

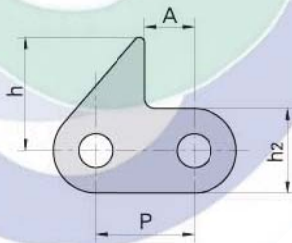

Donghua Chain No. Donghua Cadena No	P	h2	h	A
	mm	mm	mm	mm
06BF1	9.525	8.2	11.0	4.76
06BF37	9.525	8.2	10.0	4.76

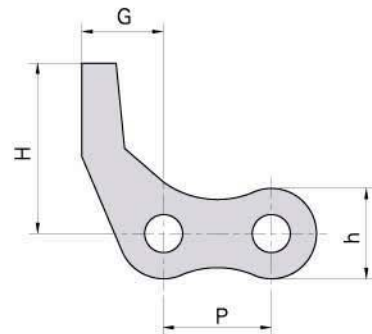

Donghua Chain No. Donghua Cadena No	P	H	h	G
	mm	mm	mm	mm
08B-D53	12.7	20	10.6	11.5

**Conveyor chain with special attachments (B series)**  
**Accesorios especiales para cadenas transportadoras (Serie B)**

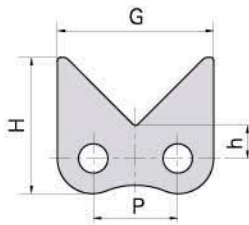

Donghua Chain No.	P	H	h	G
Donghua Cadena No	mm	mm	mm	mm
<b>08BF73</b>	12.7	20.5	5	23.5

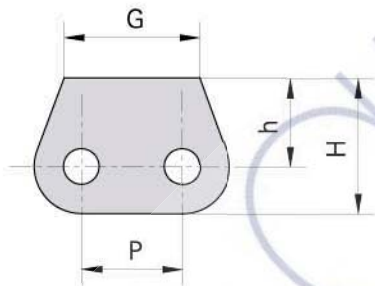

Donghua Chain No.	P	H	h	G
Donghua Cadena No	mm	mm	mm	mm
<b>08BSK0F2</b>	12.7	17	11.1	17

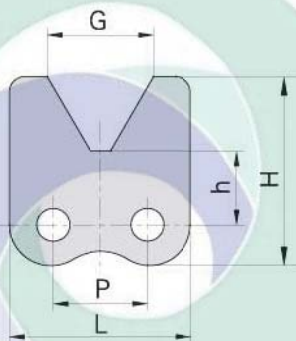

Donghua Chain No.	P	H	h	G	L
Donghua Cadena No	mm	mm	mm	mm	mm
<b>08BF61</b>	12.7	25.4	9.9	14.3	24.3

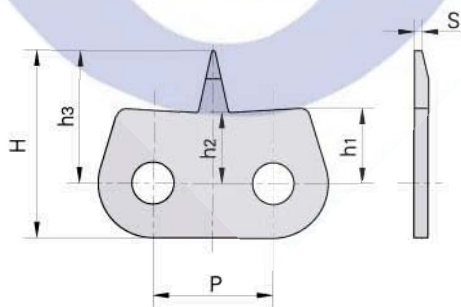

Donghua Chain No.	P	h1	h2	h3	H	s
Donghua Cadena No	mm	mm	mm	mm	mm	mm
<b>08BF11</b>	12.7	8.0	7.8	14.1	19.9	0.8

## Conveyor chain with special attachments (B series) Accesorios especiales para cadenas transportadoras (Serie B)

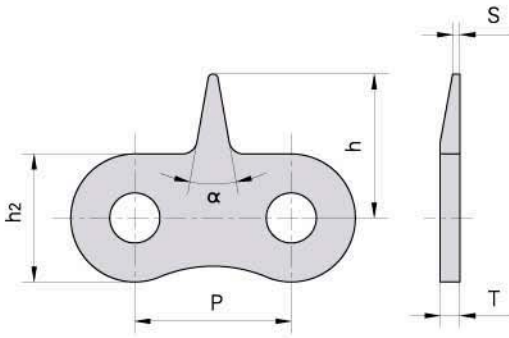

Donghua Chain No. Donghua Cadena No	P mm	h <sub>2</sub> mm	h mm	T mm	S mm	α
08BF25	12.70	10.6	15.6	1.60	-	30°
08BF29	12.70	10.6	14.5	1.60	0.8	30°
08BF30	12.70	10.6	14.5	1.60	0.3	30°
08BF35	12.70	10.6	21.5	1.60	0.6	30°
08BF67	12.70	10.6	16.1	1.60	0.3	30°
12B-1STCF1	19.05	15.0	19.0	1.85	-	30°

Donghua Chain No. Donghua Cadena No	P mm	h <sub>1</sub> mm	h <sub>2</sub> mm	h mm	A mm	α
08BF21	12.7	3.0	10.6	15.0	3.0	12°

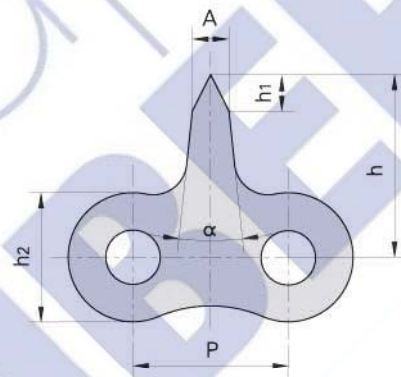

Donghua Chain No. Donghua Cadena No	P mm	R mm	h mm	α	β
08BF24	12.7	6.2	31.0	30°	75°

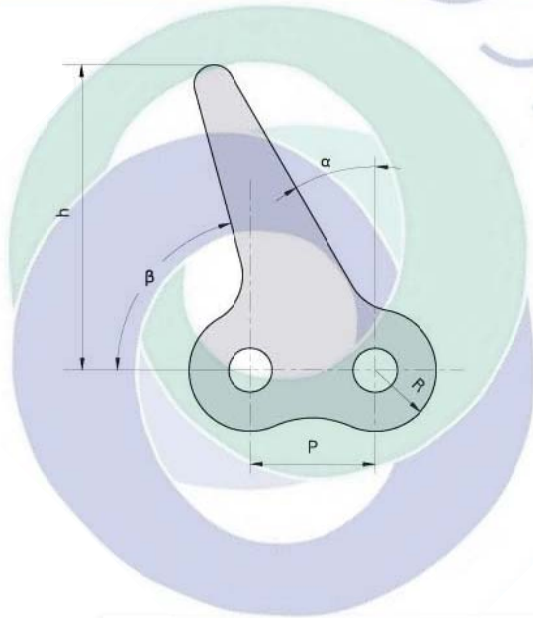

Donghua Chain No. Donghua Cadena No	P mm	h <sub>1</sub> mm	h mm	G mm
08BF37	12.7	5.0	11.8	20.0

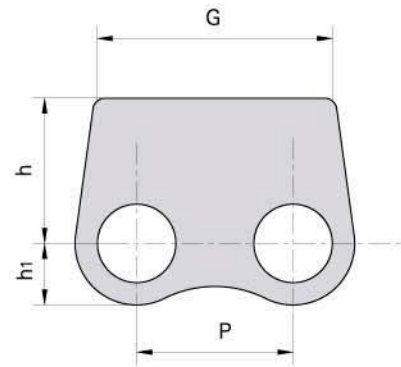

## Conveyor chain with special attachments (B series) Accesorios especiales para cadenas transportadoras (Serie B)

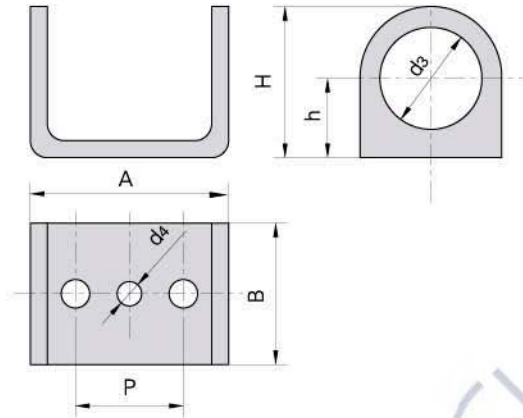

Donghua Chain No. Donghua Cadena No	P	h	H	A	B	d3	d4
	mm	mm	mm	mm	mm	mm	mm
12B-K188	19.05	14.0	26.7	35.0	25.0	18.0	4.3

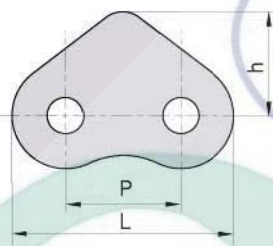

Donghua Chain No. Donghua Cadena No	P	L	h
	mm	mm	mm
16BF6	25.4	46.0	30.0

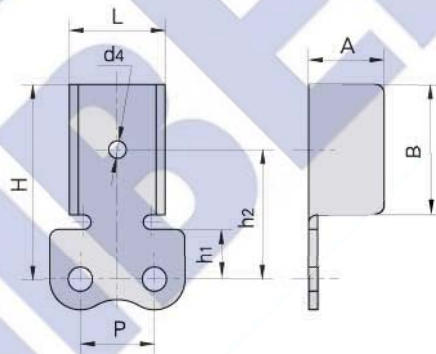

Donghua Chain No. Donghua Cadena No	P	h1	h2	H	A	B	d4	L
	mm	mm	mm	mm	mm	mm	mm	mm
16BF11	25.4	24.5	47.5	64.5	36.0	35.0	6.0	52.7

Donghua Chain No. Donghua Cadena No	P	h1	h	A	B	L
	mm	mm	mm	mm	mm	mm
20BF2	31.75	30.0	70.0	43.0	35.0	65.15

